



swiss bed concept



ACCESSOIRES

ACCESSORIES

Achten Sie auf FSC®-zertifizierte Produkte | Soyez attentifs aux produits certifiés FSC® | Look for FSC®-certified products

selezione

01

MODELLAUSWAHL

Sélection du modèle | Model selection

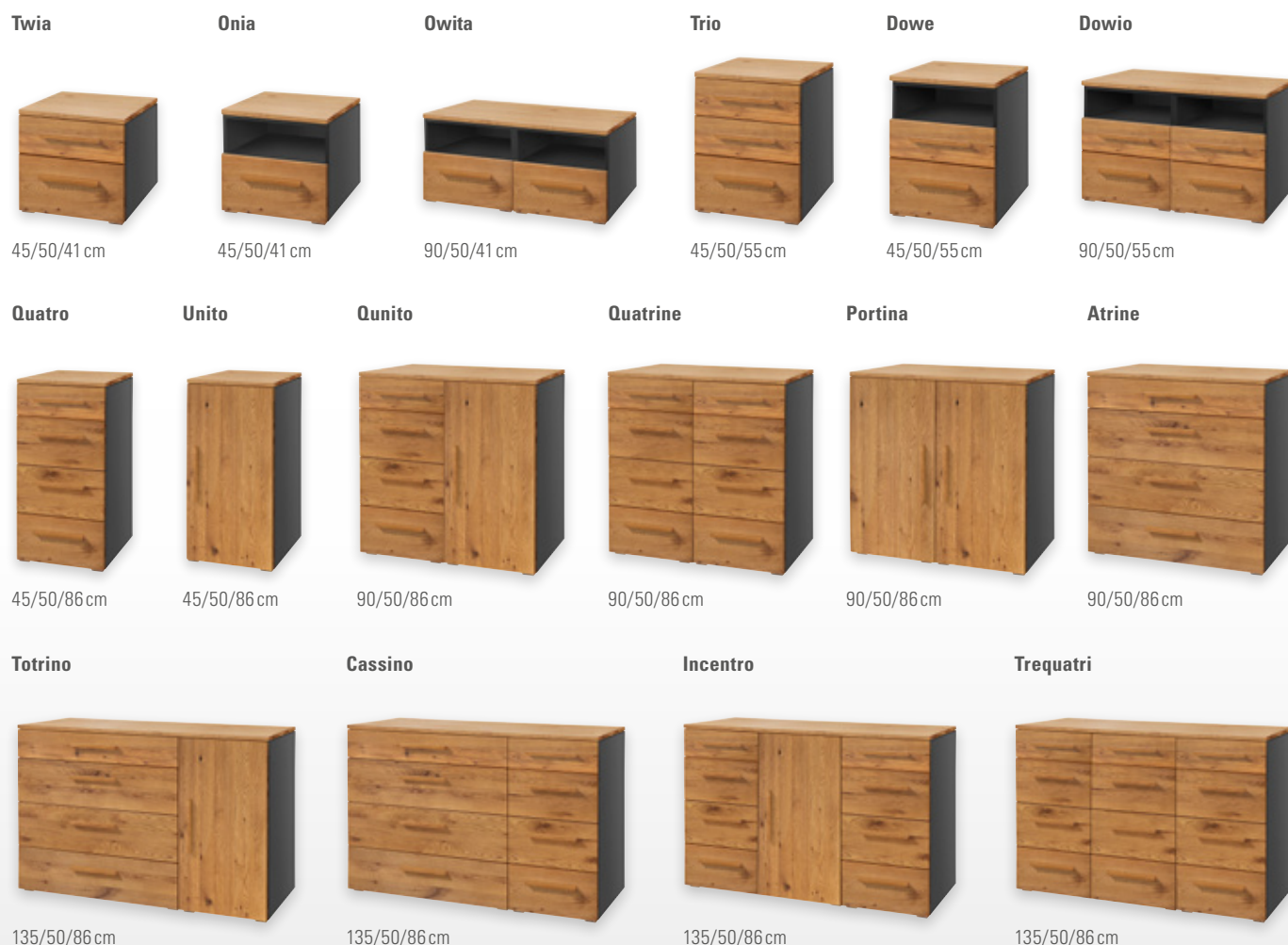
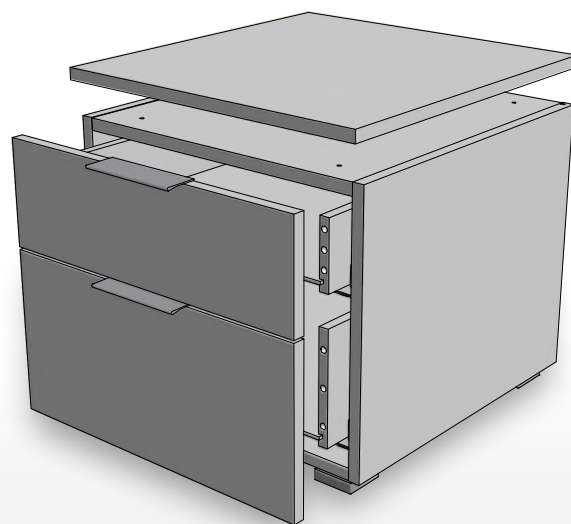

Stellen Sie sich Ihr Wunsch-Beimöbel nach Ihrem Geschmack zusammen: Der Korpus (Abb. 02), in zwei verschiedenen Farbvarianten, lässt sich zu den Front- und Top-Covern (Abb. 03) in acht Holz- und Farbausführungen kombinieren. Die Beimöbel können zerlegt oder teilmontiert bestellt werden. Bei zusammengesetzten Möbeln (z. B. Qunito, Incentro, ...) muss der Deckel noch montiert werden. Bei Kommoden mit Türen ist jeweils ein Einlegeboden vorhanden, Türöffnung nach links oder rechts möglich. Zusätzliche Böden sind erhältlich.

Composez le meuble d'appoint de vos rêves selon vos goûts : Le caisson (ill. 02), disponible en 2 variantes de couleurs, peut être combiné avec les façades et couvercles supérieurs (ill. 03) en 8 finitions de bois et de coloris. Les meubles d'appoint peuvent être commandés en kits ou assemblés. Pour les meubles assemblés (p. ex. Qunito, Incentro, ...) le couvercle doit encore être fixé. Les commodes avec portes sont équipées d'une étagère, ouverture de la porte possible à gauche ou à droite. Si besoin, des étagères supplémentaires sont disponibles.

Put together the side furniture you want according to your own taste: The body (fig. 02), in two different colour versions, can be combined with the front and top covers (fig. 03) in eight wood and colour versions. The furniture can be ordered disassembled or assembled. For assembled furniture (e.g. Qunito, Incentro, ...) the top cover must still be fitted. Chests of drawers with doors have one shelf, door opening possible to the left or right. Additional shelves are available.



Kombinationsbeispiele und techn. Informationen
Exemples et informations
Examples and informations

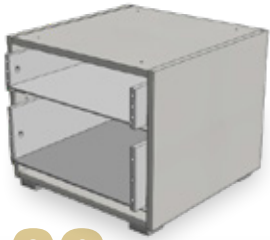

02

KORPUS

Caisson | Body



03

TOP/FRONT

Farben | Couleurs | Colours

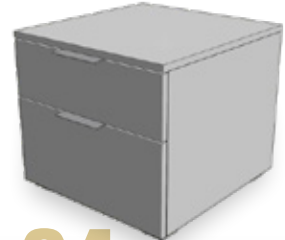

04

GRIFFE

Poignées | Handles



10 Weiss | Blanc | White



16 Anthracit | Anthracite



FÜSSE

Pieds | Feet

STANDARD



OPTION

Leg 8 cm

Jone 10 cm

Cila 10 cm



alu



anthracit
used



anthracit



10 Weiss | Blanc | White



16 Anthracit | Anthracite

STANDARD



Alu

Griff zu Folienfronten

Poignée pour façades en mélaminé
Handle for foil fronts

STANDARD



Holzgriff zu Holzfronten

Poignée en bois pour façades en bois
Wooden handle for wooden fronts

OPTION

Rivo



Used



Anthracit

Metallgriff zu Holzfronten

Poignée en métal pour façades en bois
Metal handle for wooden fronts



74 Eiche bright, geölt
Chêne bright, huilé
Oak bright, oiled

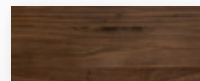

82 Nussbaum, geölt
Noyer, huilé
Walnut, oiled

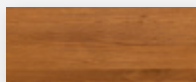

76 Eiche brandy, geölt
Chêne brandy, huilé
Oak brandy, oiled



87 Wildbuche natur, geölt
Hêtre nouveaux naturel, huilé
Wildbeech natural, oiled



80 Kernbuche natur, geölt
Hêtre coeur rouge
naturel, huilé
Heart beech natural, oiled

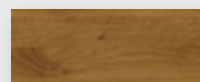

99 Wildeiche natur, geölt
Chêne nouveaux naturel, huilé
Wildoak natural, oiled



The mark of
responsible forestry
FSC® C123546

Look for FSC® certified products

Nachttische | Tables de nuit | Bedside tables

Akai

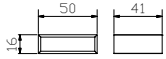

Caja

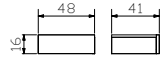

Cara

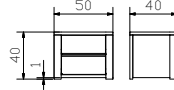

Carpi

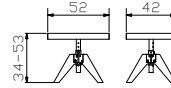

Chilly

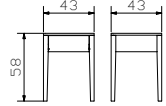

Circo 44/52

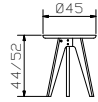

Cuba

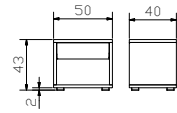

Cubo

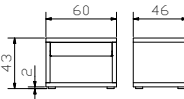

Cura

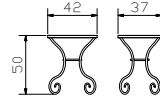

Drift

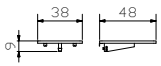

Dupla

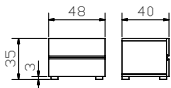

Jaca

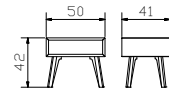

Jago

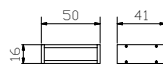

Jesa

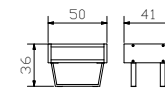

Jose

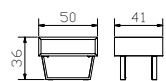

Koro

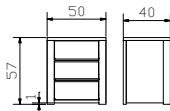

Lica

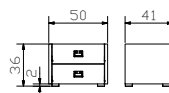

Lina

anthracit, bronze, copper

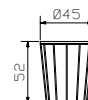

Ludo

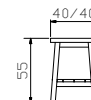

Menza

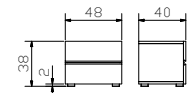

Mido

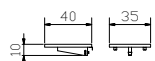

Nali

anthracit, bronze, copper



Noma

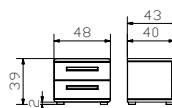

Osta

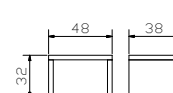

Salva

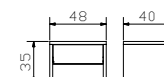

Seva

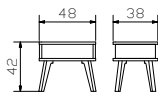
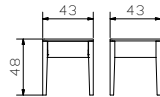
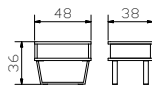
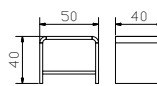
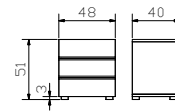
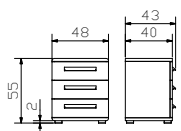
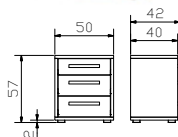
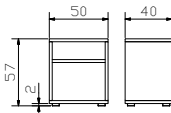
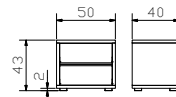
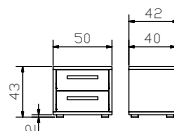

Stand**Styly****Surf****Talo****Treva****Trigo****Turina****Turo****Vera****Vero****Holzfarben (Ansicht Farben siehe Seite 2.13) | Couleurs bois (voir couleurs page 2.13) | Wood colours (see colours page 2.13)**

	06	07	09	10	62	64	70	71	73	74	76	80	82	86	87	89	90	91	93	96	98	99	
Akai				•				•				•	•										•
Caja	•	•	•	•					•	•	•	•	•	•	•	•	•	•	•	•	•	•	•
Cara														•		•		•		•			
Carpi					•	•	•													•	•		
Chilly									•				•										
Circo 44/52				•					•			•	•										
Cuba																			•		•		
Cubo																		•					
Cura*																							
Drift				•						•			•			•							•
Dupla	•	•	•							•	•	•											
Jaca				•				•				•	•										•
Jago					•	•	•																
Jesa					•	•	•																
Jose				•				•				•	•										•
Koro														•		•			•	•			
Lica					•	•	•																
Lina				•				•				•	•										
Ludo																		•		•	•		
Menza																				•	•	•	
Mido	•	•	•							•	•	•											
Nali				•				•				•	•										
Noma				•					•			•	•										
Osta										•										•	•	•	
Salva				•				•				•	•										•
Seva				•						•		•	•			•							•
Stand				•						•		•	•			•							•
Styly				•						•	•	•	•			•							•
Surf				•						•		•	•			•							•
Talo														•		•							
Treva	•	•	•							•	•	•						•	•				
Trigo				•								•	•										
Turo																•					•		
Turina																				•	•		
Vera															•						•		
Vero																	•			•	•		

*erhältlich in Eisen weiss 10 und schmiedeeisernfarbig 78 | disponible en métal en fer blanc 10 et teinté fer 78 | available in iron white 10 and iron coloured 78

Kommoden | Commodes | Chests of drawers



Aida

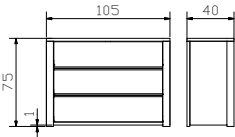

Calino 

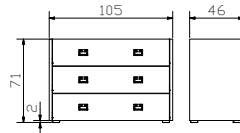

Cassetto

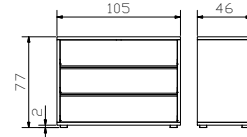

Cessina

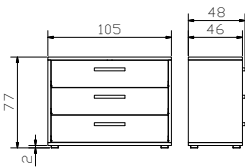

Lovara

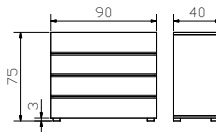

Sigma

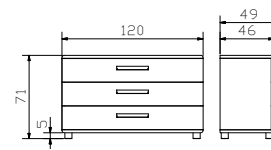

Holzfarben (Ansicht Farben siehe Seite 2.13) | Couleurs bois (voir couleurs page 2.13) | Wood colours (see colours page 2.13)

	06	07	09	10	62	64	70	73	74	76	80	82	86	87	89	90	91	93	96
Aida													•		•		•	•	
Calino					•	•	•												
Cassetto														•					•
Cessina																•		•	•
Lovara	•	•	•						•	•	•								
Sigma				•				•				•	•						

Bedienungskomfort | Facilité d'utilisation | Ease of use

Blumotion

Für unsere Nachttische und Kommoden verwenden wir ausschliesslich den gedämpften Selbstzug Blumotion von BLUM. | Pour nos tables de nuit et commodes nous utilisons exclusivement les tiroirs avec système d'amortissement Blumotion de BLUM. | For our bedside tables and chests of drawers we utilize exclusively the silent and soft self closing drawer runner Blumotion of BLUM.



Tip-On

Öffnen durch Antippen: ausgewählte Beimöbel, Lovie-Box/Lovie-Ron Box und diverse Function-Betten (Register 13) verfügen über diese mechanische Öffnungsunterstützung, welche ganz ohne Griffe auskommt.

Ouverture par pression : certains accessoires, les box Lovie-Box/Lovie-Ron Box et divers lits Function (registre 13) sont équipés de cette assistance mécanique, qui ne nécessite aucune poignée.

Opening by tapping: selected accessories, Lovie-Box/ Lovie-Ron Box and various Function beds (index 13) have this mechanical opening support, which does not require any handles at all.

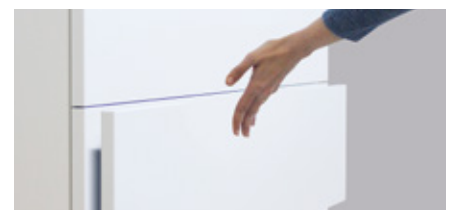

Füsse & Griffe | Pieds & Poignées | Feet & Handles

Sima 10/20



Cua 7



Loa 7



Leg 8



Jone 10



Cila 10



Seca



Rivo



Fuss Set (4 Stk.) | Set de pieds (4 pcs.) | Set of feet (4 pcs.)

Option zu | Option pour | Option to:

Nachttische

Tables de nuit | Bedside tables
Menza, Noma, Trigo, Vera

Kommoden

Commodes | Chests of drawers
Cessina, Cassetto, Sigma

Option zu | Option pour | Option to:

Nachttische

Tables de nuit | Bedside tables
Noma, Trigo, Turina

Kommoden

Commodes | Chests of drawers
Cessina, Sigma

Farben | Couleurs | Colours

	04	10	16	42	71	73	80	82	87	93	96
Cila 10			•								
Cua 7									•	•	•
Leg 8				•							
Loa 7									•	•	•
Jone 10	•		•								
Sima 10/20		•			•	•	•	•			

Holzfarben (Ansicht Farben siehe Seite 2.13) | Couleurs bois (voir couleurs page 2.13) | Wood colours (see colours page 2.13)

Case Winkel | Case Angle

Zur Montage an Calino oder Lica (4 Stk.)

Pour le montage sur Calino ou Lica (4 pcs.)
For mounting on Calino or Lica (4 pcs.)



Ausführungen Metall | Exécutions métal | Executions metal



00 Chrom

04 Used

10 White

16 Anthracit

40 Bronze

41 Copper

42 Alu

43 Inox

45 Iron

00 Chrom = Edelstahl poliert | Acier inoxydable poli | Stainless steel polished

04 Used = Stahl galvanisiert | Acier galvanisé | Steel galvanised

10 White = Stahl pulverbeschichtet | Acier thermolaqué | Steel powder-coated

16 Anthracit = Stahl pulverbeschichtet | Acier thermolaqué | Steel powder-coated

40 Bronze = Stahl lackiert | Acier laqué | Steel lacquered

41 Copper = Stahl lackiert | Acier laqué | Steel lacquered

42 Alu = Stahl pulverbeschichtet | Acier thermolaqué | Steel powder-coated

43 Inox = Edelstahl geschliffen | Acier inoxydable poncé | Stainless steel ground

45 Iron = Stahl geflammt, pulverbeschichtet | Acier flammé, thermolaqué | Steel mottled, powder-coated

Zubehör für Cielo/Cielo-Ron | Accessoires pour Cielo/Cielo-Ron | Accessories for Cielo/Cielo-Ron

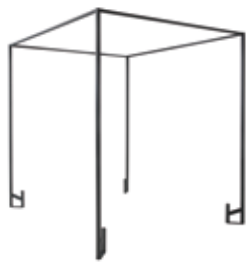

Cielo

Baldachin | Baldaquin | Canopy

Breiten | Largeurs | Widths
120, 140, 160, 180, 200 cm

Längen | Longueurs | Lengths
200, 210, 220 cm

Höhe | Hauteur | Height
200 cm



Curty

Vorhang (3er Set), Baumwolle weiss | Rideau (set de 3), Coton blanc | Curtain (set of 3), Cotton white

Dimension
272/185 cm (3x)



Vela

Baldachin-Tuch, Baumwolle weiss | Tissu de baldaquin, Coton blanc | Canopy cloth, Cotton white

Breiten | Largeurs | Widths
120, 140, 160, 180, 200 cm

Länge | Longueur | Length
200 cm

Beimöbel | Accessoires | Accessories

Bank und Kissen | Banquette et coussins | Bench and cushions

Calmo

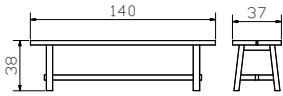

Coban

anthracit, copper, bronze

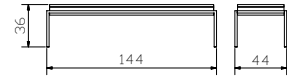

Sola

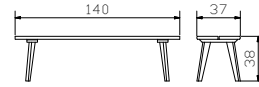

Vecio

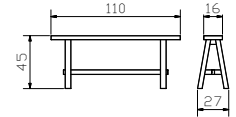

***Pato**

anthracit

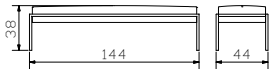

Topa

anthracit, bronze, copper

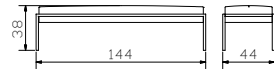

Topia

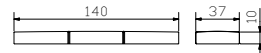

Vano



***Stoffauswahl Pato** | Choix de tissus Pato | Choice of fabrics Pato



Pepe beige 327



Pepe grey 335



Buffalo shale 720

Weitere Informationen siehe Dream Pronto | Davantage informations plus détaillées voir Dream Pronto | Further information see Dream Pronto

Kissen zu Coban, Sola und Calmo | Coussin pour Coban, Sola et Calmo | Cushion for Coban, Sola and Calmo - **Stoffauswahl siehe Register 1** | Choix de tissus voir registre 1 | Choice of tissues see index 1

Herrendiener | Valet | Dressboy

Claudio alu, anthracit, iron

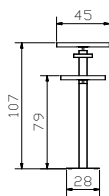

Holzfarben (Ansicht Farben siehe Seite 2.13) | Couleurs bois (voir couleurs page 2.13) | Wood colours (see colours page 2.13)

	10	62	64	70	73	74	76	80	82	86	87	89	90	91	93	96	98
Calmo											•				•	•	
Claudio	•				•	•	•	•	•	•	•	•	•	•	•	•	•
Coban		•	•	•													
Sola	•				•	•	•	•	•	•		•		•			
Vecio													•		•	•	

Sekretär | Secrétaire | Bureau

Aska



Coset

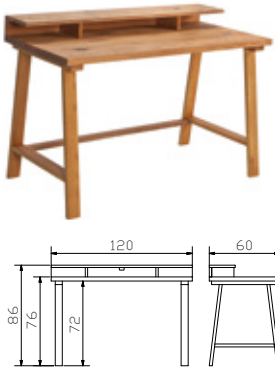

Scola 

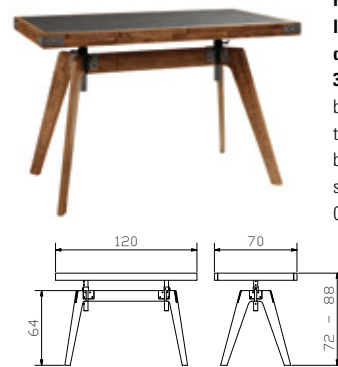

Mit Schreibunterlage aus Kunstleder Casual carbon 334 | Sous-main de bureau en cuir synthétique Casual carbon 334 | Deskpad in synthetic leather Casual carbon 334

Holzfarben (Ansicht Farben siehe Seite 2.13) | Couleurs bois (voir couleurs page 2.13) | Wood colours (see colours page 2.13)

	10	62	64	70	73	80	82	86	89	91	93	96
Aska	•				•	•	•	•	•	•		
Coset											•	•
Scola		•	•	•								

Zubehör | Accessoires | Accessories

Panel-Hold (für Wandpaneele | pour panneaux muraux | for wall panels)

Beschlag für die direkte Montage am Bettrahmen.

Dieser Beschlag ist nur anwendbar mit folgenden Wandpaneelen: Colina L, Saia M/L, Sogno L und Umbia L

Visserie pour montage direct au cadre de lit. Cette visserie est uniquement compatible avec les panneaux muraux suivants : Colina L, Saia M/L, Sogno L et Umbia L | Fitting to assemble directly to the bed frame. This fitting is only applicable with the wall panels: Colina L, Saia M/L, Sogno L and Umbia L



Adapter | Adaptateur | Adapter

Bei hohen Matratzen kann mit dem Verlängerungsadapter das Kopfteil erhöht werden.

La tête de lit peut être rehaussée avec l'adaptateur lorsque le matelas est plus épais.

With the extension adapter the headboard can be extended if mattresses are high.

Head-Plus

Metal | Métal | Metal



alu black

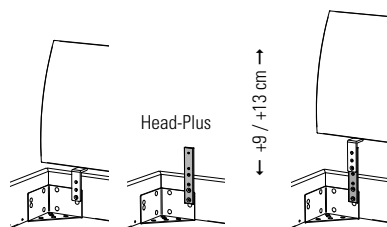

Balco-Hold L (Balco, Inca)

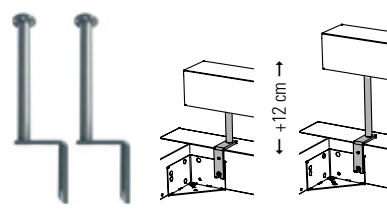

iron

Head-Hold für Wasserbetten | pour lits à eau | for waterbeds

Kopfteilhalterung zur Befestigung an Bodenplatte bei freistehenden Softside-Wasserbetten mit Sockelhöhen von 10–32 cm | Fixation pour tête de lit sur la plaque de fond des lits à eau Softside, dont la hauteur du socle varie entre 10–32 cm | Headboard fitting for fastening to the floor plate on free-standing Softside of waterbed with heights of the base from 10–32 cm.

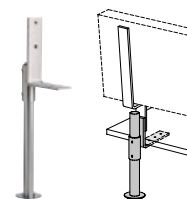

Bed-Fix

Zur Montage der Bettrahmen ohne Füße (exkl. Oak-Line, Fine-Line, Lounge)

Pour assemblage de cadres sans pieds (Oak-Line, Fine-Line, Lounge excl.)

To assemble bedframes without feet (excl. Oak-Line, Fine-Line, Lounge)



Beimöbel | Accessoires | Accessories



Roll-Box 20/25



Bettkasten in weiss oder anthrazit (Boden weiss)

Voraussetzung

Bettfußhöhe von mindestens 20 cm erforderlich

Optionen

Deckel Covero in weiss, Stoffabdeckung Saceto in Polyester grau.

Roll-Box 20/25 + Covero



Tiroir de lit en blanc ou anthracite (fond blanc)

Condition préalable

Une hauteur de pieds de lit d'au moins 20 cm est nécessaire

Options

Couvercle Covero en blanc, tissu de protection Saceto en polyester gris.

Roll-Box 20/25 + Saceto



Bed drawer in white or anthracite (bottom white)

Condition

Feet of bed need a minimum height of 20 cm

Options

Covero Covero in white, tissue of protection Saceto in polyester grey.



Roll-Box 20

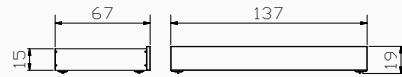

Roll-Box 25

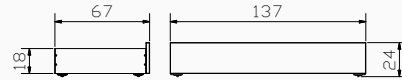

Stauraum | Espace de rangement | Storage space

Roll-Box 20	=	134 × 61 × 13 cm
Roll-Box 25	=	134 × 61 × 16 cm

Ausführungen der Roll-Box-Fronten | Exécutions des façades des Roll-Box | Executions of the Roll-Box fronts

Holz massiv | Bois massif | Solid wood



10
Buche weiss deckend, lackiert
Hêtre blanc couvrant, laqué
Beech white covered, lacquered



16
Buche anthracit deckend, lackiert
Hêtre anthracite couvrant, laqué
Beech anthracite covered, lacquered



71
Eiche bianco, geölt
Chêne bianco, huilé
Oak bianco, oiled



73
Eiche bianco, gebürstet, geölt
Chêne bianco, brossé, huilé
Oak bianco, brushed, oiled



74
Eiche bright, geölt
Chêne bright, huilé
Oak bright, oiled



80
Kernbuche natur, geölt
Hêtre coeur rouge naturel, huilé
Heart beech natural, oiled



82
Nussbaum, geölt
Noyer, huilé
Walnut, oiled



86
Eiche natur, gebürstet, geölt
Chêne naturel, brossé, huilé
Oak natural, brushed, oiled



91
Eiche cognac, gebürstet, geölt
Chêne cognac, brossé, huilé
Oak cognac, brushed, oiled



93
Wildoake natur, gebürstet, geölt
Chêne nouveau naturel, brossé, huilé
Wildoak natural, brushed, oiled

Leselampe | Lampe de lecture | Reading lamp

Boa chrom



LED
kalt weiss / einstufig
 de lumière blanche froide/
 interrupteur à 1 cran
 cold white/one level

Touch-Sensor am Lampenkopf
 Touche sensorielle à la tête de la lampe
 Touch-sensor at lamphead

12V DC, 12 LED, 60 lm

Smart white, black

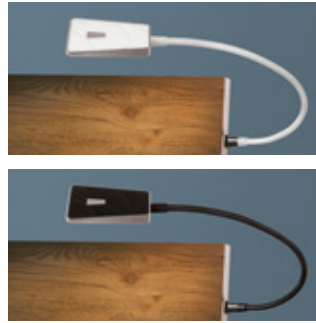

LED
warm weiss /
3 Helligkeitsstufen
 de lumière blanche chaude /
 interrupteur à 3 crans
 warm white / 3 level

Druckknopf am Lampenkopf
 Bouton-poussoir à la tête de la lampe
 Push button at lamphead

12V DC, 30 LED warm, 183 lm

Dreistufenschaltung
 Interrupteur à 3 crans
 Three-step circuit

Dieses Produkt enthält eine Lichtquelle
 der Energieeffizienzklasse F
 Ce produit contient une source lumineuse
 de classe d'efficacité énergétique F
 This product contains a light source
 of energy efficiency class F

Snake alu, anthracit

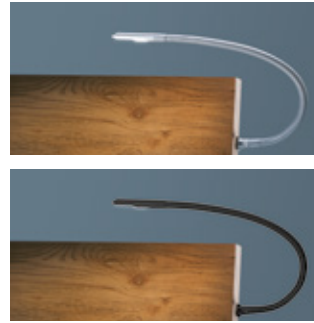

LED
3-stufig = Lichtwahl kalt weiss,
warm oder kalt/warm gemischt
 Interrupteur à 3 crans = choix de
 lumière blanche froide, chaude
 ou froide/chaude mélangées
 3 level = choice of light cold white,
 warm or cold/warm mixed

Druckknopf am Lampenkopf
 Bouton-poussoir à la tête de la lampe
 Push button at lamphead

12V DC, 6 LED, 110 lm

3 Beleuchtungsarten
 3 différent illuminations
 3 different illuminations

Dieses Produkt enthält eine Lichtquelle
 der Energieeffizienzklasse F
 Ce produit contient une source lumineuse
 de classe d'efficacité énergétique F
 This product contains a light source
 of energy efficiency class F

Tina chrom



LED
Licht neutral weiss
 Lumière blanc neutre
 Light neutral white

Druckknopf am Lampenkopf
 Bouton-poussoir à la tête de la lampe
 Push button at lamphead

12V DC, 1 LED, 75 lm

Dieses Produkt enthält eine Lichtquelle
 der Energieeffizienzklasse F
 Ce produit contient une source lumineuse
 de classe d'efficacité énergétique F
 This product contains a light source
 of energy efficiency class F

Die Leselampen sind bei gepolsterten Kopfteilen und Wandpaneelen, siehe Register 1, sowie bei sämtlichen Holzkopfteilen, siehe Register 3–13, montierbar
 Possibilité de fixation des lampes de lecture aux têtes de lit et panneaux muraux rembourrés, voir index 1, ainsi que pour toutes les têtes de lit en bois, voir index 3–13
 Possibility to fix reading lamps to upholstered headboards and wallpanels, see index 1, as well as for all wooden headboards, see index 3–13

Combino



Adapter zur Befestigung der Leselampen an folgenden Kopfteilen, Wandpaneelen und Kopfteilen Dream Pronto | Adaptateur pour la fixation des lampes de lecture aux têtes de lit, panneaux muraux et têtes de lit Dream Pronto | Adapter to mount the reading lamps to the following headboards, wallpanels and headboards Dream Pronto

Cena, Ceneri, Colina, Combia, Damo, Dolce, Dorma, Kimo, Mebo, Opera, Orion, Ronio, Siena, Zuro

Noemi, Noah

